

Product No. **BO-3108TB**

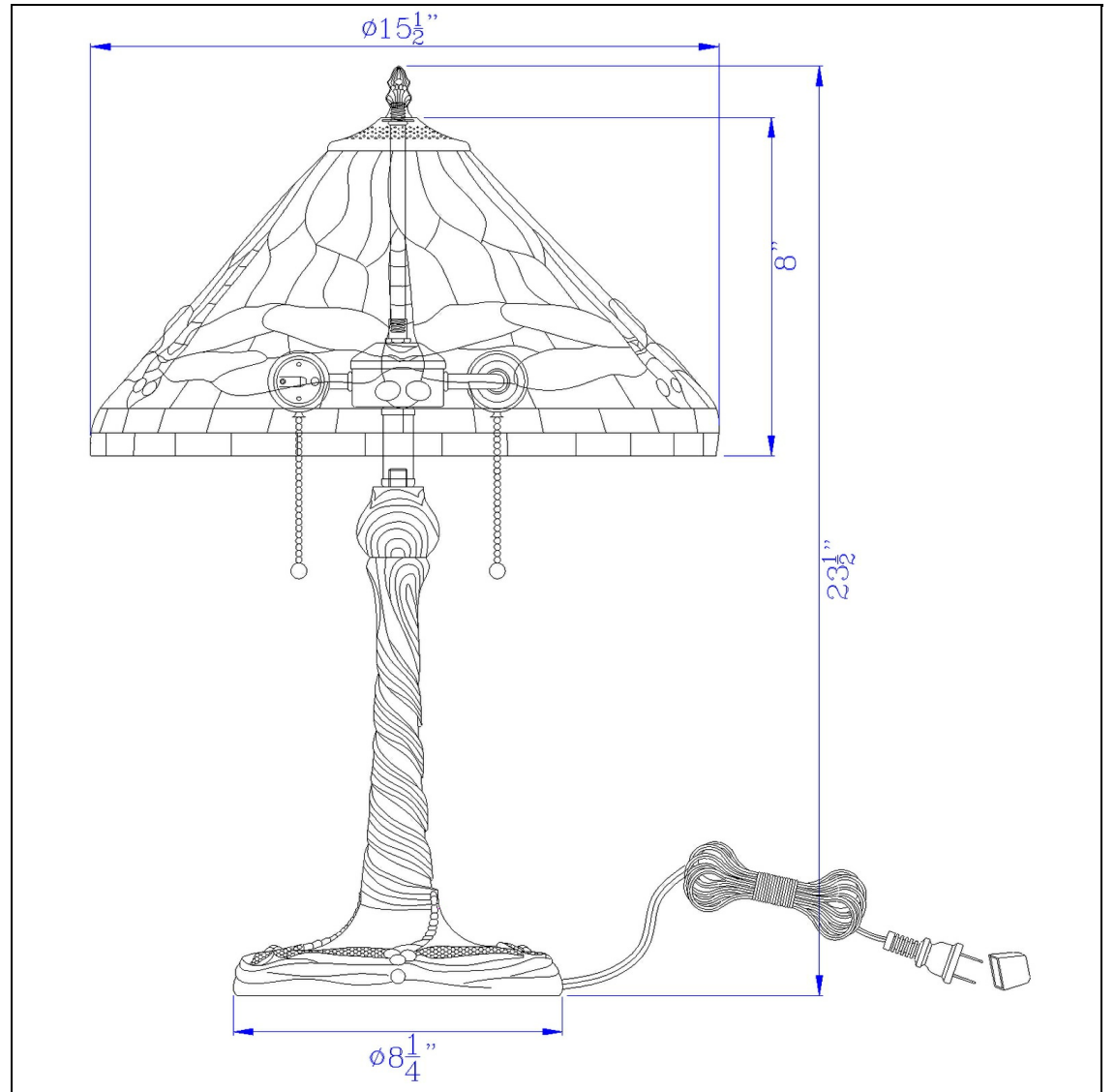

Description

60W x 2 metal/resin Tiffany table lamp with pull chain switches
Durable Resin and Metal Construction
Durable Resin and Metal Construction
Hand Painted Tiffany Glass Shade
Pull Chain Switch
Weighted Base for Added Stability
Ships in One Carton
Add a pop of color to your home with this stained glass dragon fly tiffany table lamp. It features a

Technical Specifications

UPC	020193067284	Shade Bottom1	15.50
Wattage	60W X 2	Shade Side	8.00
Switch Type	ON/OFF	Carton 1 Dimensions	24.00 x 11.30 x 19.80
Bulb Base	E26	Carton 2 Dimensions	0.00 x 0.00 x 19.80
Number of Lights	2	Package Dimensions	L: 19.80 W: 11.30 H: 24.00
Color	Antique Brass		